

GLASSWAREHOUSE

GENERAL INSTALLATION INSTRUCTIONS FOR WALL HANGING (MODEL NO. SF-R-24)

PREPARING THE MIRROR

1. Determine orientation of installation.

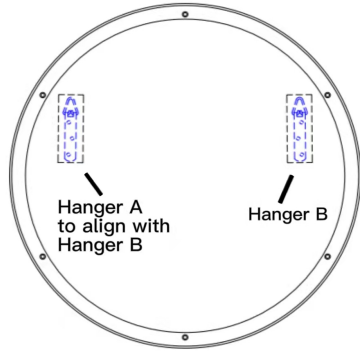

WARNING: Do not use wire between the hangers to hang the mirror from a single screw.

Location of hangers
(There may be tolerance +/- 1/8".)

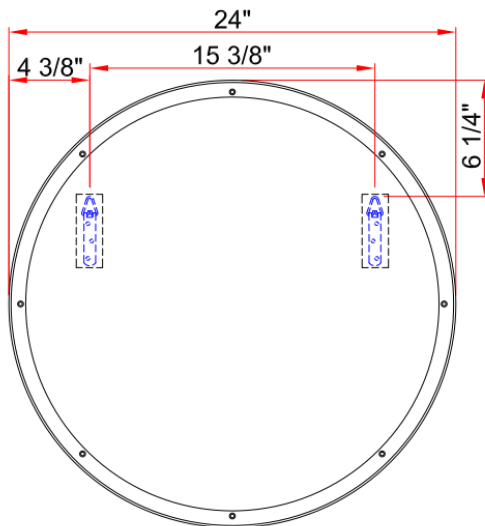

PREPARING THE WALL

2. Measure the distance between the centers of the hangers on back of mirror. *Note: There may be slight differences for each individual mirror as a result of the hand-made production process.* Mark these two points on the wall using a level.
 3. Determine which fixing method you will need and use the correct included fixings for either Drywall, Masonry, or Timber.
 - Drywall: remove the screws from the Drywall wall plugs. Using a Phillips head screwdriver in the end of the Drywall plug, gently apply pressure and rotate clockwise. The plug will bore its own hole into the Drywall. Continue until the end of the plug is close to flush with the wall. **WARNING: DO NOT OVER-TIGHTEN.**
 - Masonry: Drill holes using a 1/4" masonry drill bit. With a hammer, gently tap each Green anchor into the holes until flush with the wall surface.
- Timber: Drill holes using a 1/8" wood drill bit. Anchors are not necessary.

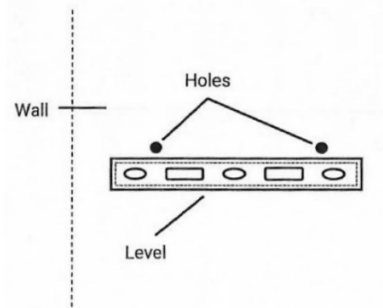

HANGING THE MIRROR

4. Install a screw into each anchor (if installing in drywall or masonry) until the head of the screw is approximately 1/4" away from the wall.
5. Test the screws by pulling outward and downward to ensure they are secure installed. The screws and anchors must remain firmly in place to ensure a safe installation.
6. Hang the mirror on the screws using the hangers on back of the mirror.

